



# METER

## TEROS 21 INTEGRATOR GUIDE

### SENSOR DESCRIPTION

The TEROS 21 Soil Water Potential Sensor measures a wide range of soil water potentials without user maintenance. This dielectric water potential sensor can be packed into a hole, plugged into a data logger, and left to log water potential data. While the TEROS 21 sensor does not have the accuracy of tensiometers, its extended range makes this sensor ideal for measuring the water potential in natural systems or other drier systems where cavitation of tensiometers is a concern. The added temperature measurements can be used to determine approximate soil water potential in frozen soils.

**NOTE:** The TEROS 21 measures the matric component of water potential. For more information on matric potential and the other components of water potential visit [Defining water potential](#).

### APPLICATIONS

- Deficit irrigation monitoring and control
- Water potential monitoring in the vadose zone
- Crop stress
- Waste water drainage studies
- Plant water availability
- SDI-12 implementation

### ADVANTAGES

- Three-wire sensor interface: power, ground, and data
- Digital sensor communicates multiple measurements over a serial interface
- Robust thermistor for accurate temperature measurements
- Low-input voltage requirements
- Low-power design supports battery-operated data loggers
- Robust epoxy encapsulation resists corrosive environments
- Supports SDI-12 or DDI serial communications protocols
- Modern design optimized for low-cost sensing
- Does not require a skilled operator
- Can measure drier systems where tensiometer cavitation is a concern
- Needs no user maintenance

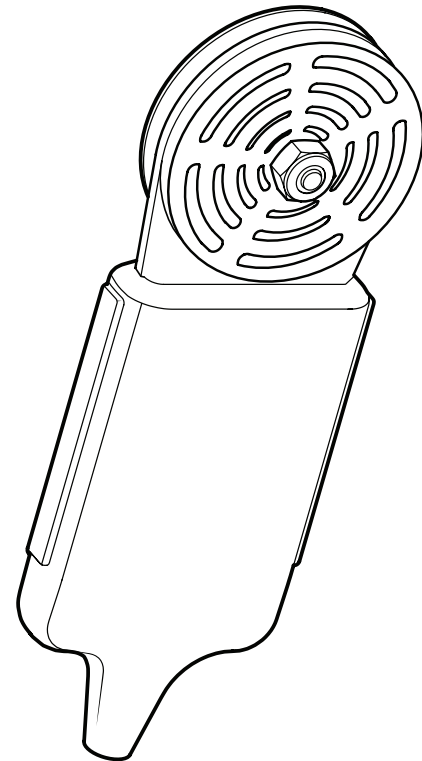

Figure 1 TEROS 21 sensor

### PURPOSE OF THIS GUIDE

METER provides the information in this integrator guide to help TEROS 21 Soil Water Potential Sensor customers establish communication between these sensors and their data acquisition equipment or field data loggers. Customers using data loggers that support SDI-12 sensor communications should consult the data logger user manual. METER sensors are fully integrated into the METER system of plug-and-play sensors, cellular-enabled data loggers, and data analysis software.

### COMPATIBLE FIRMWARE VERSIONS

This guide is compatible with firmware versions 3.89 or newer.

# SPECIFICATIONS

## MEASUREMENT SPECIFICATIONS

Water Potential	
Range	-9 to -100,000 kPa (1.96 to 6.01 pF)
Resolution	0.1 kPa
Accuracy	±(10% of reading + 2 kPa) from -9 to -100 kPa

NOTE: The TEROS 21 is not well calibrated beyond -100 kPa. For more information on using the TEROS 21 beyond this range, see the [TEROS 21 User Manual](#).

Dielectric Measurement Frequency	
	70 MHz

## COMMUNICATION SPECIFICATIONS

Output	
	RS-232 (TTL) with 3.6-V or SDI-12 communication protocol

Temperature	
Range	-40 to +60 °C
Resolution	1 °C
Accuracy	±1 °C

Data Logger Compatibility	
	Any data acquisition system capable of 3.6- to 15-VDC power and serial or SDI-12 communication

## PHYSICAL SPECIFICATIONS

Dimensions	
Length	9.6 cm (3.8 in)
Width	3.5 cm (1.4 in)
Height	1.5 cm (0.6 in)

Cable Length	
	5 m (standard) 75 m (maximum custom cable length)
	NOTE: Contact <a href="#">Customer Support</a> if a nonstandard cable length is needed.

Sensor Diameter	
	3.2 cm (1.3 in)

Connector Types	
	3.5-mm stereo plug connector or stripped and tinned wires

Operating Temperature Range	
Minimum	-40 °C
Typical	NA
Maximum	+60 °C

NOTE: Sensors may be used at higher temperatures under certain conditions; contact [Customer Support](#) for assistance.

## ELECTRICAL AND TIMING CHARACTERISTICS

Supply Voltage (VCC to GND)	
Minimum	3.6 VDC
Typical	NA
Maximum	15.0 VDC

Digital Output Voltage (logic high)	
Minimum	NA
Typical	3.6 V
Maximum	NA

Digital Input Voltage (logic high)	
Minimum	2.8 V
Typical	3.6 V
Maximum	3.9 V

Power Line Slew Rate	
Minimum	1.0 V/ms
Typical	NA
Maximum	NA

Digital Input Voltage (logic low)	
Minimum	-0.3 V
Typical	0.0 V
Maximum	0.8 V

Current Drain (during measurement)	
Minimum	3.0 mA
Typical	3.6 mA
Maximum	10.0 mA

Current Drain (while asleep)		Measurement Duration	
Minimum	NA	Minimum	NA
Typical	0.03 mA	Typical	150 ms
Maximum	NA	Maximum	200 ms
Power-Up Time (DDI serial)			
Minimum	NA		
Typical	NA		
Maximum	100 ms		
Power-Up Time (SDI-12)			
Minimum	100 ms		
Typical	150 ms		
Maximum	200 ms		

## COMPLIANCE

Manufactured under ISO 9001:2015  
EM ISO/IEC 17050:2010 (CE Mark)

## EQUIVALENT CIRCUIT AND CONNECTION TYPES

Refer to [Figure 2](#) and [Figure 3](#) to connect the TEROS 21 to a data logger. [Figure 2](#) provides a low-impedance variant of the recommended SDI-12 specification.

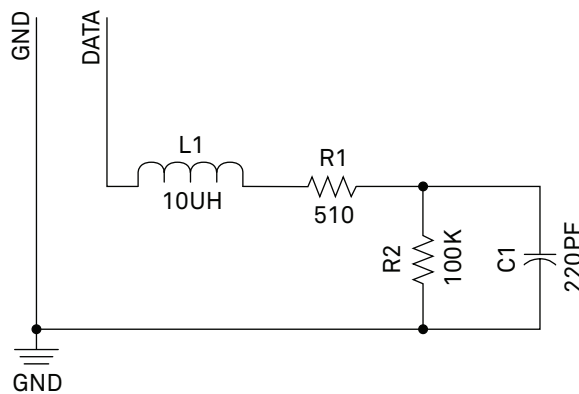
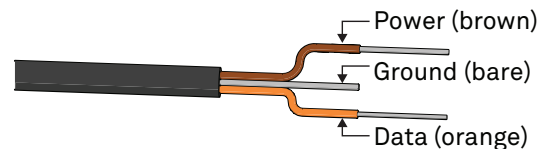

Figure 2 Equivalent circuit diagram

### PIGTAIL CABLE



NOTE: Sensors manufactured as MPS-6 have the older Decagon wiring scheme where the power supply is white, the digital out is red, and the bare wire is ground.

### STEREO CABLE



Figure 3 Connection types

## ⚠ PRECAUTIONS

METER sensors are built to the highest standards, but misuse, improper protection, or improper installation may damage the sensor and possibly void the warranty. Before integrating sensors into a sensor network, follow the recommended installation instructions and implement safeguards to protect the sensor from damaging interference.

## SURGE CONDITIONS

Sensors have built-in circuitry that protects them against common surge conditions. Installations in lightning-prone areas, however, require special precautions, especially when sensors are connected to a well-grounded third-party logger.

Read the application note [Lightning surge and grounding practices](#) on the METER website for more information.

## POWER AND GROUNDING

Ensure there is sufficient power to simultaneously support the maximum sensor current drain for all the sensors on the bus. The sensor protection circuitry may be insufficient if the data logger is improperly powered or grounded. Refer to the data logger installation instructions. Improper grounding may affect the sensor output as well as sensor performance.

Read the application note [Lightning surge and grounding practices](#) on the METER website for more information.

## CABLES

Improperly protected cables can lead to severed cables or disconnected sensors. Cabling issues can be caused by many factors, including rodent damage, driving over sensor cables, tripping over the cable, not leaving enough cable slack during installation, or poor sensor wiring connections. To relieve strain on the connections and prevent loose cabling from being inadvertently snagged, gather and secure the cable travelling between the ATMOS 41 and the data acquisition device to the mounting mast in one or more places. Install cables in conduit or plastic cladding when near the ground to avoid rodent damage. Tie excess cable to the data logger mast to ensure cable weight does not cause sensor to unplug.

## SENSOR COMMUNICATIONS

METER digital sensors feature a serial interface with shared receive and transmit signals for communicating sensor measurements on the data wire ([Figure 3](#)). The sensor supports two different protocols: SDI-12 and DDI serial. Each protocol has implementation advantages and challenges. Please contact [Customer Support](#) if the protocol choice for the desired application is not obvious.

### SDI-12 INTRODUCTION

SDI-12 is a standards-based protocol for interfacing sensors to data loggers and data acquisition equipment. Multiple sensors with unique addresses can share a common 3-wire bus (power, ground, and data). Two-way communication between the sensor and logger is possible by sharing the data line for transmit and receive as defined by the standard. Sensor measurements are triggered by protocol command. The SDI-12 protocol requires a unique alphanumeric sensor address for each sensor on the bus so that a data logger can send commands to and receive readings from specific sensors.

Download the [SDI-12 Specification v1.3](#) to learn more about the latest SDI-12 protocol.

### DDI SERIAL INTRODUCTION

The DDI serial protocol is the method used by METER data loggers for collecting data from the sensor. This protocol uses the data line configured to transmit data from the sensor to the receiver only (simplex). Typically, the receive side is a microprocessor UART or a general-purpose I/O pin using a bitbang method to receive data. Sensor measurements are triggered by applying power to the sensor.

### INTERFACING THE SENSOR TO A COMPUTER

The serial signals and protocols supported by the sensor require some type of interface hardware to be compatible with the serial port found on most computers (or USB-to-serial adapters). There are several SDI-12 interface adapters available in the marketplace; however, METER has not tested any of these interfaces and cannot make a recommendation as to which adapters work with METER sensors. METER data loggers and the ProCheck hand-held device can operate as a computer-to-sensor interface for making on-demand sensor measurements. For more information, please contact [Customer Support](#).

### METER SDI-12 IMPLEMENTATION

METER sensors use a low-impedance variant of the SDI-12 standard sensor circuit ([Figure 2](#)). During the power-up time, the sensors output some sensor diagnostic information and should not be communicated with until the power-up time has passed. After the power-up time, the sensors are compatible with all commands listed in the [SDI-12 Specification v1.3](#) except for the continuous measurement commands (aR0–aR9 and aRC0–aRC9). M, R, and C command implementations are found on pages 7–8. The aR3 and aR4 commands are used by METER systems and as a result use a space delimiter, instead of a sign delimiter as required by the SDI-12 standard.

Out of the factory, all METER sensors start with SDI-12 address 0 and print out the DDI serial startup string during the power-up time. This can be interpreted by non-METER SDI-12 sensors as a pseudo-break condition followed by a random series of bits.

The TEROS 21 will omit the DDI serial startup string (sensor identification) when the SDI-12 address is nonzero. Changing the address to a nonzero address is recommended for this reason.

## SENSOR BUS CONSIDERATIONS

SDI-12 sensor buses require regular checking, sensor upkeep, and sensor troubleshooting. If one sensor goes down, it may take down the whole bus even if the remaining sensors are functioning normally. Power cycling the SDI-12 bus when a sensor is failing is acceptable, but METER does not recommend scheduling power cycling events on an SDI-12 bus more than once or twice per day. Many factors influence the effectiveness of the bus configuration. Visit [metergroup.com](http://metergroup.com) for articles and virtual seminars containing more information.

## SDI-12 CONFIGURATION

Table 1 lists the SDI-12 communication configuration.

**Table 1 SDI-12 communication configuration**

Baud Rate	1,200
Start Bits	1
Data Bits	7 (LSB first)
Parity Bits	1 (even)
Stop Bits	1
Logic	Inverted (active low)

## SDI-12 TIMING

All SDI-12 commands and responses must adhere to the format in Figure 4 on the data line. Both the command and response are preceded by an address and terminated by a carriage return and line feed combination (<CR><LF>) and follow the timing shown in Figure 5.

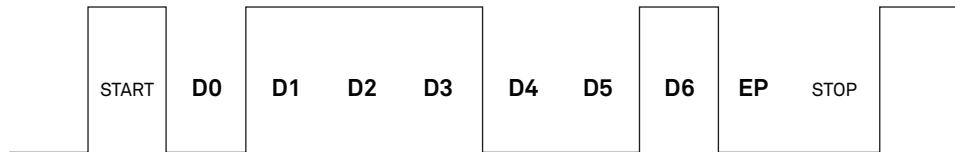

**Figure 4 Example SDI-12 transmission of the character 1 (0x31)**

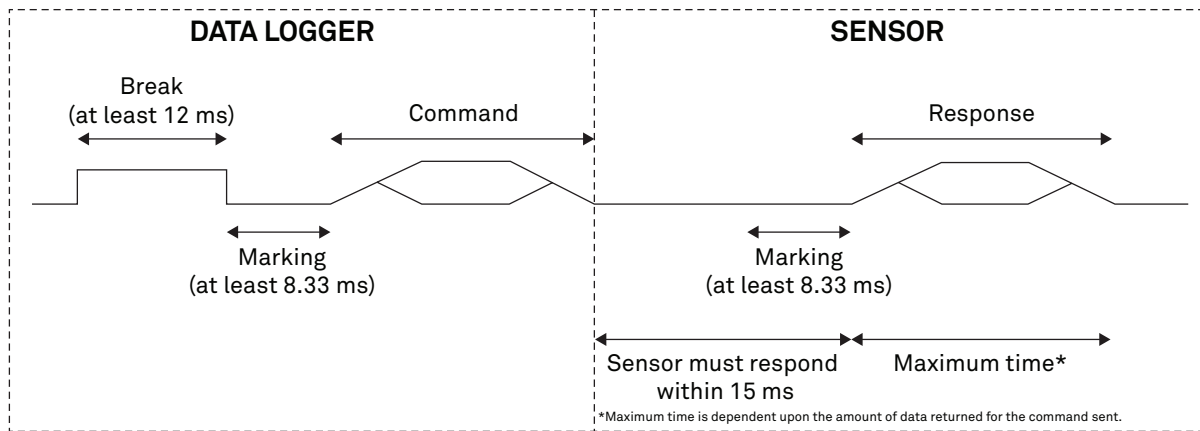

**Figure 5 Example data logger and sensor communication**

## COMMON SDI-12 COMMANDS

This section includes tables of common SDI-12 commands that are often used in an SDI-12 system and the corresponding responses from METER sensors.

### IDENTIFICATION COMMAND (aI!)

The Identification command can be used to obtain a variety of detailed information about the connected sensor. An example of the command and response is shown in Example 1, where the command is in **bold** and the response follows the command.

**Example 1** 1I!113METER \_ \_ \_ TER21 \_ 337631800001

<u>Parameter</u>	<u>Fixed Character Length</u>	<u>Description</u>
1I!	3	Data logger command. Request to the sensor for information from sensor address 1.
1	1	Sensor address. Prepended on all responses, this indicates which sensor on the bus is returning the following information.
13	2	Indicates that the target sensor supports <a href="#">SDI-12 Specification v1.3</a> .
METER _ _ _ _	8	Vendor identification string. (METER and three spaces _ _ _)
TER21 _	6	Sensor model string. This string is specific to the sensor type. For the TEROS 21, the string is TER21.
389	3	Sensor version. This number divided by 100 is the METER sensor version (e.g., 389 is version 3.89).
631800001	≤13, variable	Sensor serial number. This is a variable length field. It may be omitted for older sensors.

**NOTE:** In the event that the fixed length is longer than the parameter, the trailing characters will be populated with space characters.

### CHANGE ADDRESS COMMAND (aAB!)

The Change Address command is used to change the sensor address to a new address. All other commands support the wildcard character as the target sensor address except for this command. All METER sensors have a default address of 0 (zero) out of the factory. Supported addresses are alphanumeric (i.e., a–z, A–Z, and 0–9). An example output from a METER sensor is shown in [Example 2](#), where the command is in **bold** and the response follows the command.

**Example 2** 1A0!0

<u>Parameter</u>	<u>Fixed Character Length</u>	<u>Description</u>
1A0!	4	Data logger command. Request to the sensor to change its address from 1 to a new address of 0.
0	1	New sensor address. For all subsequent commands, this new address will be used by the target sensor.

### ADDRESS QUERY COMMAND (?!)

While disconnected from a bus, the Address Query command can be used to determine which sensor is currently being communicated with. Sending this command over a bus will cause a bus contention where all the sensors will respond simultaneously and corrupt the data line. This command is helpful when trying to isolate a failed sensor. [Example 3](#) shows an example of the command and response, where the command is in **bold** and the response follows the command. The question mark (?) is a wildcard character that can be used in place of the address with any command except the Change Address command.

**Example 3** ?!0

<u>Parameter</u>	<u>Fixed Character Length</u>	<u>Description</u>
?!	2	Data logger command. Request for a response from any sensor listening on the data line.
0	1	Sensor address. Returns the sensor address to the currently connected sensor.

### COMMAND IMPLEMENTATION

The following tables list the relevant Measurement (M), Continuous (R), and Concurrent (C) commands and subsequent Data (D) commands, when necessary.

## MEASUREMENT COMMAND IMPLEMENTATION

Measurement (M) commands are sent to a single sensor on the SDI-12 bus and require that subsequent Data (D) commands are sent to that sensor to retrieve the sensor output data before initiating communication with another sensor on the bus.

Please refer to [Table 2](#) and for an explanation of the command sequence and see [Table 7](#) for an explanation of response parameters.

**Table 2 aM! measurement command sequence**

Command	Response
This command reports instantaneous values.	
aM!	attn
aD0!	a-<matricPotential>±<temperature>

NOTE: The measurement and corresponding data commands are intended to be used back to back. After a measurement command is processed by the sensor, a service request a <CR><LF> is sent from the sensor signaling the measurement is ready. Either wait until *ttt* seconds have passed or wait until the service request is received before sending the data commands. See the [SDI-12 Specifications v1.3](#) document for more information.

## CONCURRENT MEASUREMENT COMMANDS IMPLEMENTATION

Concurrent (C) measurement commands are typically used with sensors connected to a bus. Concurrent (C) commands for this sensor deviate from the standard C command implementation. First, send the C command, wait the specified amount of time detailed in the C command response, and then use D commands to read its response prior to communicating with another sensor.

Please refer to [Table 3](#) for an explanation of the command sequence and see [Table 7](#) for an explanation of response parameters.

**Table 3 aC! measurement command sequence**

Command	Response
This command reports instantaneous values.	
aC!	attnn
aD0!	a-<matricPotential>±<temperature>

NOTE: This command does not adhere to the SDI-12 concurrent command requirements. See [METER SDI-12 Implementation](#) for more information.

NOTE: The measurement and corresponding data commands are intended to be used back to back. After a measurement command is processed by the sensor, a service request a <CR><LF> is sent from the sensor signaling the measurement is ready. Either wait until *ttt* seconds have passed or wait until the service request is received before sending the data commands. See the [SDI-12 Specifications v1.3](#) document for more information.

## CONTINUOUS MEASUREMENT COMMANDS IMPLEMENTATION

Continuous (R) measurement commands trigger a sensor measurement and return the data automatically after the readings are completed without needing to send a D command.

Please refer to [Table 4](#) through [Table 6](#) for an explanation of the command sequence and see [Table 7](#) for an explanation of response parameters.

**Table 4 aR0! measurement command sequence**

Command	Response
This command reports instantaneous values.	
aR0!	a-<matricPotential>±<temperature>

NOTE: This command does not adhere to the SDI-12 response timing. See [METER SDI-12 Implementation](#) for more information.

**Table 5 aR3! measurement command sequence**

Command	Response
This command reports instantaneous values.	
aR3!	a<TAB><matricPotential> <temperature><CR><sensorType><Checksum><CRC>

NOTE: This command does not adhere to the SDI-12 response format or timing. See [METER SDI-12 Implementation](#) for more information.

**Table 6 aR4! measurement command sequence**

Command	Response
NOTE: This command reports instantaneous values.	
aR4!	a<TAB><matricPotential> <temperature><CR><sensorType><Checksum><CRC>

NOTE: This command does not adhere to the SDI-12 response timing. See [METER SDI-12 Implementation](#) for more information.

## PARAMETERS

Table 7 lists the parameters, unit measurement, and a description of the parameters returned in command responses for TEROs 21.

**Table 7 Parameter Descriptions**

Parameter	Unit	Description
±	—	Positive or negative sign denoting sign of the next value
a	—	SDI-12 address
n	—	Number of measurements (fixed width of 1)
nn	—	Number of measurements with leading zero if necessary (fixed width of 2)
ttt	s	Maximum time measurement will take (fixed width of 3)
<TAB>	—	Tab character
<CR>	—	Carriage return character
<LF>	—	Line feed character
<matricPotential>	kPa	Matric potential
<temperature>	°C	Air temperature
<sensorType>	—	ASCII character denoting the sensor type For TEROs 21, the character is k
<Checksum>	—	METER serial checksum
<CRC>	—	METER 6-bit CRC

## DDI SERIAL COMMUNICATION

The DDI serial communications protocol is ideal for systems that have dedicated serial signaling lines for each sensor or use a multiplexer to handle multiple sensors. The serial communications are compatible with many TTL serial implementations that support active-high logic levels using 0.0 to 3.6 VDC signal levels. When the sensor is first powered, it automatically makes measurements of the integrated transducers then outputs a response over the data line. Systems using this protocol control the sensor excitation to initiate data transfers from the sensor. This protocol is subject to change as METER improves and expands the line of digital sensors and data loggers.

TEROS 21 will omit the DDI serial startup string when the SDI-12 address is nonzero.

NOTE: Out of the factory, all METER sensors start with SDI-12 address 0 and print out the startup string when power cycled. On sensors with firmware version 3.37 and newer the startup string is omitted when the address is nonzero.



## DDI SERIAL TIMING

Table 8 lists the DDI serial communication configuration.

**Table 8 DDI serial communication configuration**

Baud Rate	1,200
Start Bits	1
Data Bits	8 (LSB first)
Parity Bits	0 (none)
Stop Bits	1
Logic	Standard (active high)

At power up, the sensor will pull the data line high within 100 ms to indicate that the sensor is taking a reading (Figure 6). When the reading is complete, the sensor begins sending the serial signal out the data line adhering to the format shown in Figure 7. Once the data is transmitted, the sensor goes into SDI-12 communication mode. To get another serial signal, the sensor must be power cycled.

**NOTE:** Sometimes the signaling from the sensor can confuse typical microprocessor UARTs. The sensor holds the data line low while taking measurements. The sensor raises the line high to signal the logger that it will send a measurement. Then the sensor may take some additional measurements before starting to clock out the first data byte starting with a typical start bit (low). Once the first start bit is sent, typical serial timing is valid; however, the signal transitions before this point are not serial signaling and may be misinterpreted by the UART.

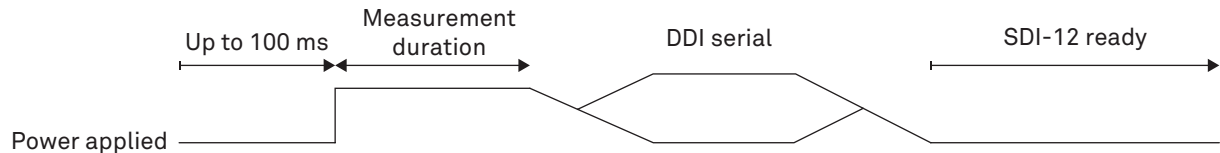

**Figure 6 Data line DDI serial timing**

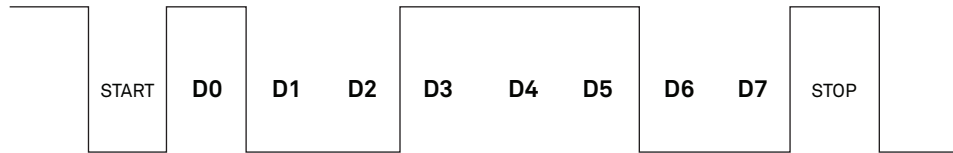

**Figure 7 Example DDI serial transmission of the character 9 (0x39)**

## DDI SERIAL RESPONSE

Table 9 details the DDI serial response.

**Table 9 DDI serial response**

COMMAND	RESPONSE
-	<TAB><matricPotential> <temperature><CR><sensorType><Checksum><CRC>

## DDI SERIAL CHECKSUM

The legacy checksum is computed from the start of the transmission to the sensor identification character. These checksums are used in the continuous commands R3 and R4 as well as the DDI serial response.

Legacy checksum example input is <TAB>-34.8 22.3<CR>k@1 and the resulting checksum output is @.

```

uint8_t LegacyChecksum(const char * Response)
{
    uint16_t length;
    uint16_t i;
    uint16_t sum = 0

    // Finding the length of the response string
    length = strlen(response);

    // Adding characters in the response together
    for( i = 0; i < length; i++ )
    {
        sum += response[i];

        if(response[i] == '\r')
        {
            //Found the beginning of the metadata section of the response
            break;
        }
    }

    // Include the sensor type into the checksum
    sum += response[++i];

    // Convert checksum to a printable character
    sum = sum % 64 + 32;

    return sum;
}

```

The more robust CRC6, if available, utilizes the CRC-6-CDMA2000-A polynomial with the value 48 added to the results to make this a printable character and is computed from the start of the transmission to the legacy checksum character.

CRC6 checksum example input is <TAB>-34.8 22.3<CR>k01 and the resulting checksum output is 1 (lowercase L).

```

uint8_t CRC6_Offset(uint8_t *buffer, uint16_t bytes)
{
    uint16_t byte;
    uint8_t bit;
    uint8_t crc = 0xfc; // Set upper 6 bits to 1's

    // Loop through all the bytes in the buffer
    for(byte = 0; byte < bytes; byte++)
    {
        // Get the next byte in the buffer and XOR it with the crc
        crc ^= buffer[byte];

        // Loop through all the bits in the current byte
        for(bit = 8; bit > 0; bit--)
        {
            // If the uppermost bit is a 1...
            if(crc & 0x80)
            {
                // Shift to the next bit and XOR it with a polynomial
                crc = (crc << 1) ^ 0x9c;
            }
            else
            {
                // Shift to the next bit
                crc = crc << 1;
            }
        }

        // Shift upper 6 bits down for crc
        crc = (crc >> 2);

        // Add 48 to shift crc to printable character avoiding \r \n and !
        return (crc + 48);
    }
}

```

## CUSTOMER SUPPORT

Customer service representatives are available for questions, problems, or feedback Monday through Friday, 7 am–5 pm Pacific time.

**Email:** [support.environment@metergroup.com](mailto:support.environment@metergroup.com)  
[sales.environment@metergroup.com](mailto:sales.environment@metergroup.com)

**Phone:** +1.509.332.5600

**Fax:** +1.509.332.5158

**Website:** [metergroup.com](http://metergroup.com)

If contacting METER by email, please include the following information:

Name	Email address
Address	Instrument serial number
Phone number	Description of problem

**NOTE:** For TEROS 21 sensors purchased through a distributor, please contact the distributor directly for assistance.

## REVISION HISTORY

The following table lists document revisions.

Revision	Date	Compatible Firmware	Description
02	8.10.2018	3.89	Corrected outputs and changed parameter to <matrixPotential>
01	5.31.2018	3.89	Updated legacy checksum image
00	11.10.2018	3.89	Rebranded document for METER.